



ECLIPSE Ti2

Inverted Research Microscope



Enter the "Microscopy University" on the web and discover a whole new world. <https://www.microscopyu.com>

The Digital Sight series and Imaging Software NIS-Elements are not for clinical diagnostic use.

Specifications and equipment are subject to change without any notice or obligation on the part of the manufacturer. January 2023 © 2018-23 NIKON CORPORATION

WARNING TO ENSURE CORRECT USAGE, READ THE CORRESPONDING MANUALS CAREFULLY BEFORE USING YOUR EQUIPMENT.

Monitor images are simulated.
Company names and product names appearing in this brochure are their registered trademarks or trademarks.
N.B. Export of the products* in this brochure is controlled under the Japanese Foreign Exchange and Foreign Trade Law. Appropriate export procedure shall be required in case of export from Japan.
*Products: Hardware and its technical information (including software)



NIKON CORPORATION

Shinagawa Intercity Tower C, 2-15-3, Konan, Minato-ku, Tokyo 108-6290, Japan
phone: +81-3-6433-3705 fax: +81-3-6433-3785
<https://www.healthcare.nikon.com/en/>



Nikon Instruments Inc.
1300 Walt Whitman Road, Melville, N.Y. 11747-3064, U.S.A.
phone: +1-631-547-8500; +1-800-52-NIKON (within the U.S.A. only)
fax: +1-631-547-0299
<https://www.microscope.healthcare.nikon.com/>

Nikon Europe B.V.
Stroombaan 14, 1181 VX Amstelveen, The Netherlands
phone: +31-20-7099-000
https://www.microscope.healthcare.nikon.com/en_EU/

Nikon Precision (Shanghai) Co., Ltd.
CHINA phone: +86-21-6841-2050 fax: +86-21-6841-2060
(Beijing branch) phone: +86-10-5831-2028 fax: +86-10-5831-2026
(Guangzhou branch) phone: +86-2-3882-0551 fax: +86-2-3882-0580
https://www.microscope.healthcare.nikon.com/zh_CN/

Nikon Canada Inc.
CANADA phone: +1-905-625-9910 fax: +1-905-602-9953
Nikon France, Succursale de Nikon Europe B.V.
FRANCE phone: +33-1-4516-4516

Nikon Deutschland, Zweigniederlassung der Nikon Europe B.V.
GERMANY phone: +49-211-9414-888
Nikon Italy, Branch of Nikon Europe B.V.
ITALY phone: +39-055-300-9601

Nikon Europe B.V., Amstelveen, Zweigniederlassung Schweiz (Egg/ZH)
SWITZERLAND phone: +41-43-277-2867
Nikon UK, Branch of Nikon Europe B.V.
UNITED KINGDOM phone: +44-208-247-1717

Nikon Österreich, Zweigniederlassung der Nikon Europe B.V.
AUSTRIA phone: +43-1-972-6111
Nikon Singapore Pte. Ltd.
SINGAPORE phone: +65-6559-3651 fax: +65-6559-3668
Nikon Australia Pty Ltd
AUSTRALIA phone: +61-2-8767-6900
Nikon Instruments Korea Co., Ltd.
KOREA phone: +82-2-6288-1900 fax: +82-2-555-4415

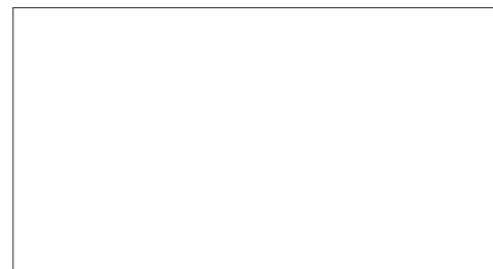

ISO 14001 Certified for NIKON CORPORATION

See More Than Before

Leading platform for advanced imaging

The ECLIPSE Ti2 delivers an unparalleled 25mm field of view (FOV) that revolutionizes the way you see. With this incredible FOV, the Ti2 maximizes the sensor area of large-format CMOS cameras without making compromises, and significantly improves data throughput.

The Ti2's exceptionally stable, drift-free platform is designed to meet the demands of super-resolution imaging while its unique hardware-triggering capabilities enhance even the most challenging, high-speed imaging applications. Furthermore, the Ti2's unique, intelligent functions guide users through imaging workflows by gathering data from internal sensors, eliminating the possibility of user errors. In addition, the status of each sensor is automatically recorded during acquisition, providing quality control for imaging experiments and enhancing data reproducibility.

In combination with Nikon's powerful acquisition and analysis software, NIS-Elements, the Ti2 is a total innovation in imaging.

Contents

Groundbreaking FOV	P4	Intuitive operation	P12
High-quality Nikon optics	P6	System expandability	P14
Focus perfected	P8	NIS-Elements	P16
Assist Guide	P10	System diagrams	P18



**ECLIPSE
Ti2-E**



**ECLIPSE
Ti2-A**



Motorized and intelligent model for advanced imaging applications. Compatible with PFS, auto correction collar, and external phase contrast system. The base of choice for live-cell imaging, high-content applications, confocal and super-resolution.

Manual model with imaging capability for laser applications. Intelligent features provide interactive guidance through imaging workflows and automatically detect microscope status.

Groundbreaking FOV

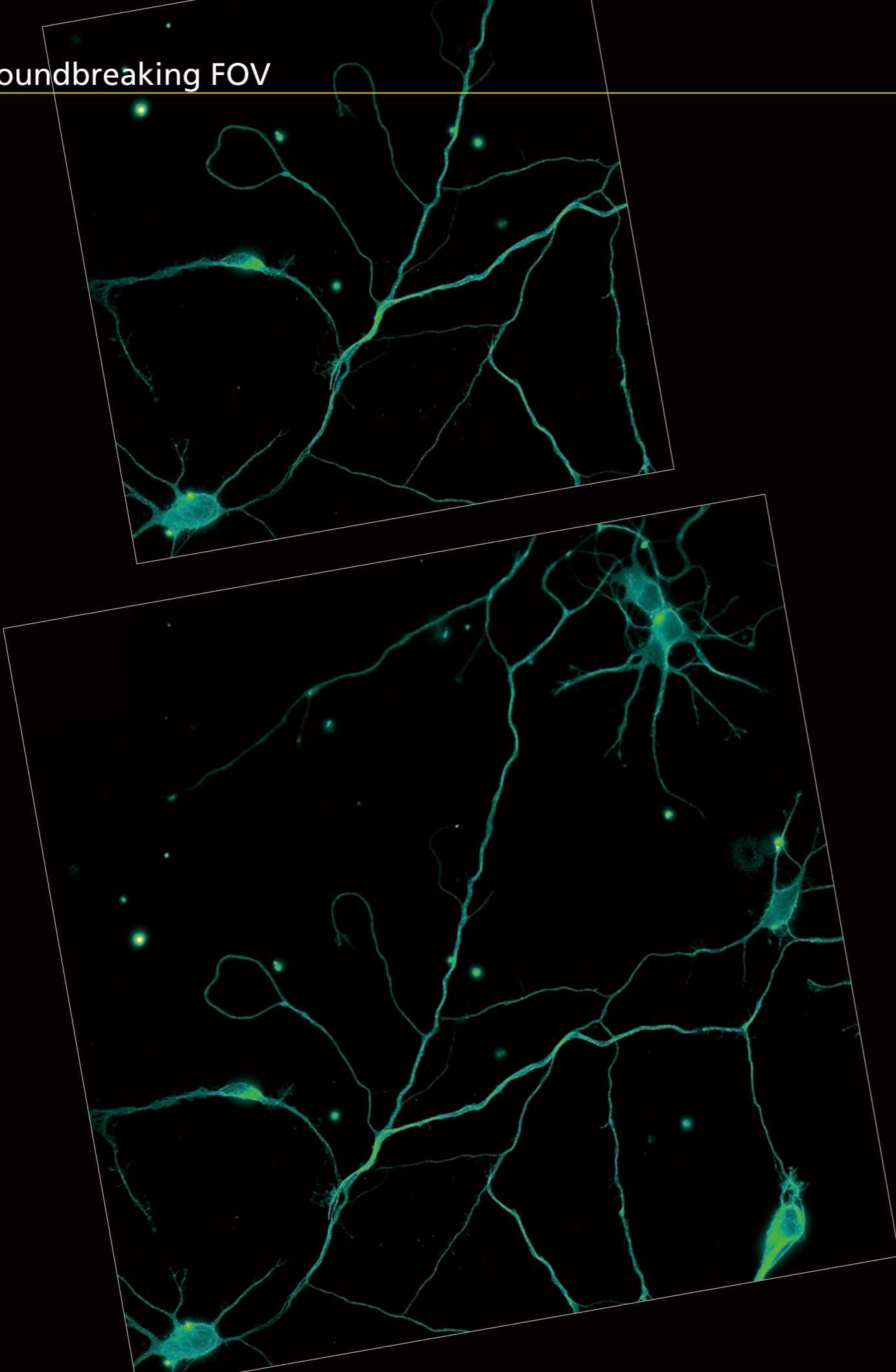

As research trends evolve towards large-scale, systems-level approaches, there is an increasing demand for faster data acquisition and higher throughput capabilities. Development of large-format camera sensors and improvements in the data processing capabilities of PCs have facilitated such research trends. The Ti2, with its unprecedented 25mm field of view, provides the next level of scalability, enabling researchers to truly maximize the utility of large-format detectors and future-proof their core imaging platform as camera technologies continue to develop at a rapid pace.

Bright illumination over a wide area

High-power LEDs deliver bright illumination across the Ti2's large field of view, ensuring clear, consistent results from demanding applications such as high-magnification DIC. Incorporation of a fly-eye lens design provides uniform illumination from edge to edge for quantitative high-speed imaging and seamless tiling of images in stitching applications.

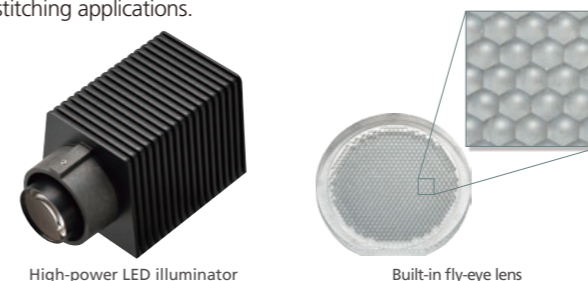

High-power LED illuminator

Built-in fly-eye lens

A compact epi-fluorescence module designed for large FOV imaging provides high transmittance across a broad spectrum, including UV. Large diameter fluorescence filters with hard coatings deliver large FOV images with a high signal-to-noise ratio.



Epi-fluorescence module

Large diameter fluorescence filter cubes

Large diameter observation optics

The diameter of the observation light path has been enlarged in order to achieve a field number of 25 at the imaging port. The resulting large FOV is capable of capturing approximately double the area of conventional optics, enabling users to gain maximum performance from large-format sensors such as CMOS detectors.



Enlarged tube lens

Imaging port with large 25 field number

Objectives for large FOV imaging

Objectives with superior image flatness ensure high quality images from edge to edge. Utilizing the maximum potential of the OFN25 objective significantly accelerates data collection.



Cameras for large-volume data acquisition

Nikon's FX-format F-mount cameras Digital Sight 10 and Digital Sight 50M are equipped with CMOS image sensors optimized for research use, originally developed for professional D-SLR cameras. This allows high-speed and high-sensitivity live-cell imaging, enabling the best use to be made of the Ti2's large FOV.



D-SLR camera technology optimized for microscopy

Digital Sight 10

Digital Sight 50M

Image on page 4
Neuron culture stained for microtubules (Alexa Fluor® 488), captured with CFI Plan Apochromat Lambda 60XC objective and DS-Qi2 camera. Conventional FOV on top and new Ti2 FOV on bottom.
Photo courtesy of Josh Rappoport, Nikon Imaging Center, Northwestern Univ.; Sample courtesy of S. Kemal, B. Wang, and R. Vassar, Northwestern Univ.

High-quality Nikon optics

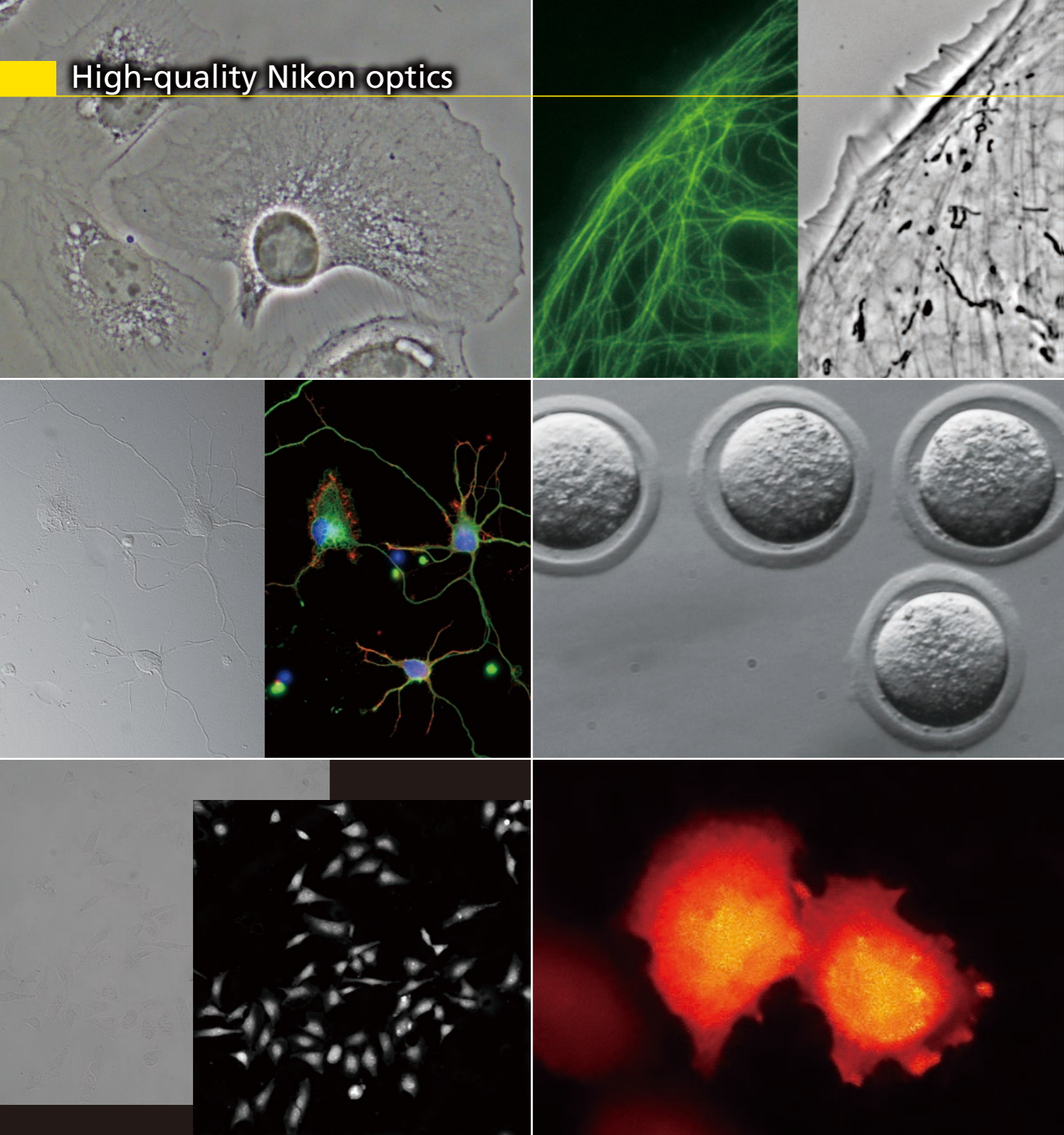

Apodized phase contrast image:
BSC-1 cells captured with CFI S Plan Fluor ELWD ADM 40XC objective

DIC and epi-fluorescence images:
25mm FOV image of neurons (DAPI, Alexa Fluor® 488, Rhodamine-Phalloidin), captured with CFI Plan Achromat Lambda 60XC objective and DS-Qi2 camera
Photo courtesy of Josh Rappoport, Nikon Imaging Center, Northwestern Univ.;
Sample courtesy of S. Kemal, B. Wang, and R. Vassar, Northwestern Univ.

Brightfield and Volume Contrast images:
HeLa cells captured with CFI S Plan Fluor ELWD 20XC objective

Epi-fluorescence and external phase contrast images:
PTK-1 cells labeled with GFP-alpha-tubulin captured with CFI Achromat TIRF 100XC Oil objective
Photo courtesy of Alexey Khodjakov, Ph.D Research Scientist VI / Professor, Wadsworth Center

NAMC image:
Mouse embryos, captured with CFI S Plan Fluor ELWD NAMC 20XC objective

Luminescence image:
HeLa cells expressing BRET-based calcium indicator protein, Nano-lantern (Ca²⁺).
Sample courtesy of Prof. Takeharu Nagai, The Institute of Scientific and Industrial Research, Osaka University

Nikon's high-precision CFI60 infinity optics, designed for use with a variety of sophisticated observation methods, are highly regarded by researchers for their superb optical performance and solid reliability.

Apodized phase contrast

Nikon's unique apodized phase contrast objectives with selective amplitude filters dramatically increase contrast and reduce halo artifacts to provide detailed high-definition images.

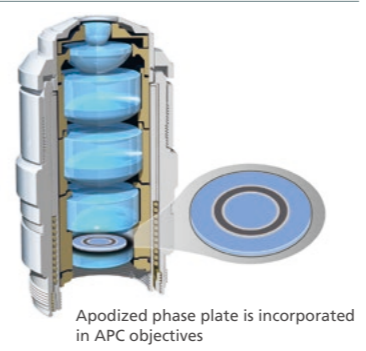

DIC (Differential Interference Contrast)

Nikon's highly-regarded DIC optics provide uniformly clear and detailed images with high resolution and contrast throughout the magnification range. DIC prisms are individually tailored for each objective lens to provide the highest-quality DIC images for every sample.



DIC prisms matched to individual objectives are mounted in the nosepiece

Volume Contrast (Ti2-E)

Volume Contrast imaging utilizes label-free, brightfield images captured at various Z-depths to assemble a phase distribution image. Volume Contrast renders cells easily identifiable as objects for automated counting and area analysis. As this method utilizes brightfield imaging, Volume Contrast enables in-line, non-destructive analysis of cells, suitable for various applications.

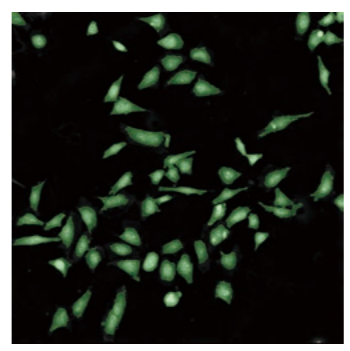

Binarized image analyzed by Volume Contrast

External phase contrast (Ti2-E)

The motorized external phase-contrast system enables users to combine phase contrast with epi-fluorescence imaging without compromising fluorescent light transmission by bypassing the need to use phase-contrast objectives. For example, very high NA, liquid immersion objectives can be used for phase-contrast imaging. Using this external phase contrast system, users can easily combine phase contrast with other imaging modalities, including weak-fluorescence imaging such as TIRF and laser tweezer applications.

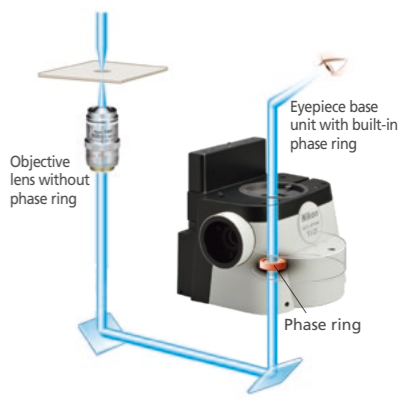

NAMC (Nikon Advanced Modulation Contrast)

This is a plastic-compatible, high-contrast imaging technique for unstained, transparent samples such as oocytes. NAMC provides pseudo-three-dimensional images with a shadow-cast appearance. The direction of contrast can be easily adjusted for each sample.

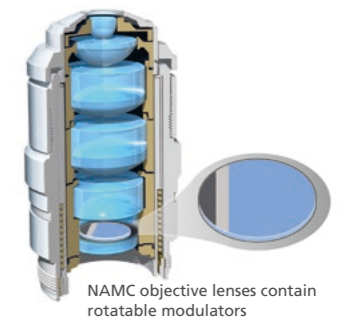

NAMC objective lenses contain rotatable modulators

Epi-fluorescence

The Lambda D series objectives, utilizing Nikon's proprietary Nano Crystal Coat technology, are perfect for demanding, low-signal, multi-channel fluorescence imaging that requires high transmission and aberration correction over a wide wavelength range. Combined with new fluorescence filter cubes that offer improved fluorescence detection and stray light countermeasures such as the Noise Terminator, the Lambda D series objectives demonstrate their power in weak signal observations such as single-molecule imaging and even luminescence-based applications.

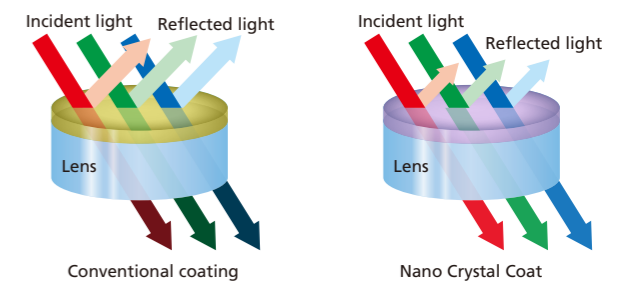

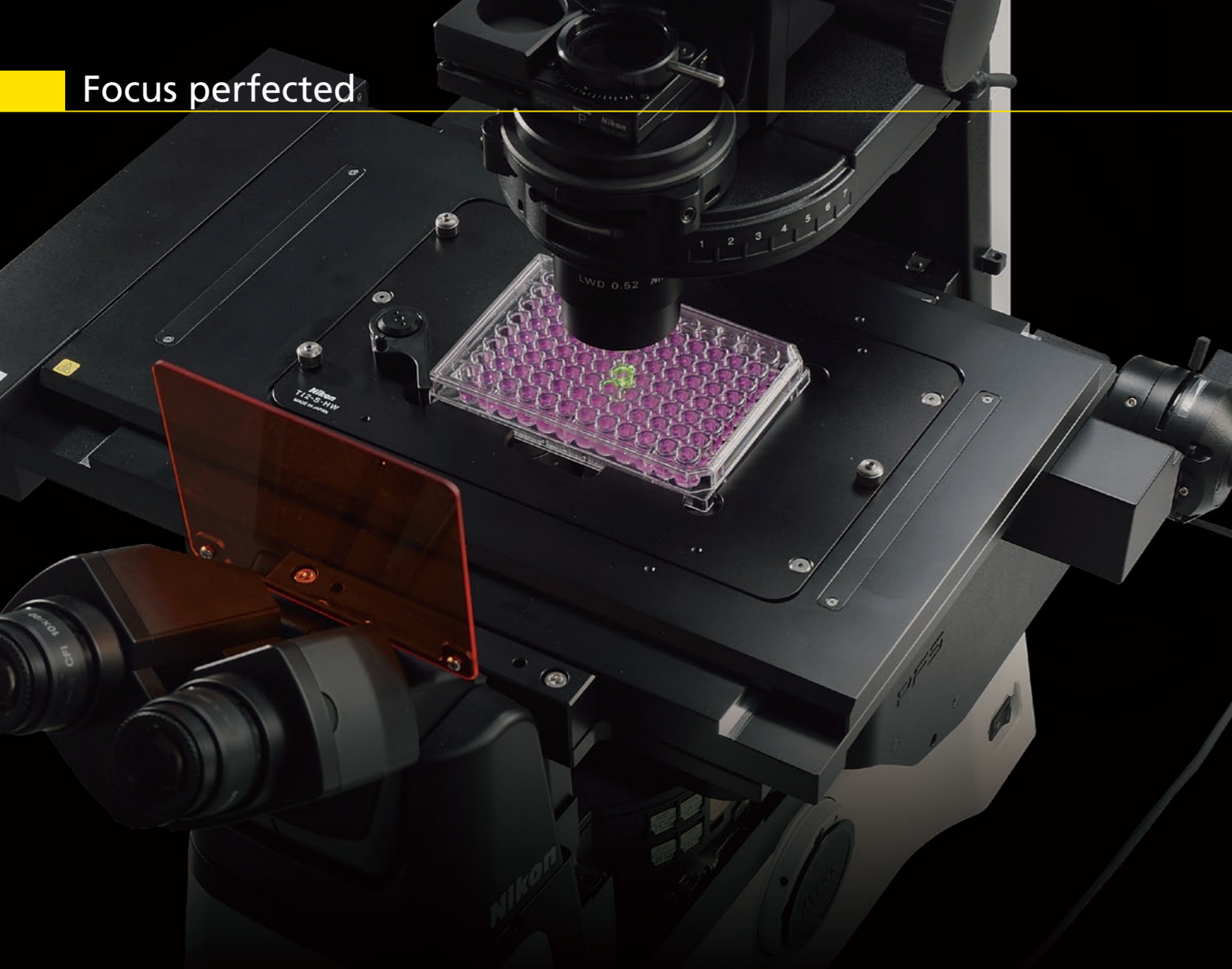

Even the slightest change in temperature and vibrations in the imaging environment can greatly impact focus stability. The Ti2 eliminates focus drift using both static and dynamic measures to enable faithful visualization of the nanoscopic and microscopic world during long time-lapse experiments.

Mechanically redesigned for ultra-high stability (Ti2-E)

In order to improve the focusing stability, both Z-drive and PFS autofocus mechanisms have been completely re-designed. The new Z-focusing mechanism is smaller and positioned adjacent to the nosepiece to minimize vibrations. It remains adjacent to the nosepiece even in an expanded (staged-up) configuration, ensuring stability for all applications.

The detector portion of the Perfect Focus System (PFS) has been detached from the nosepiece in order to reduce mechanical load on the objective nosepiece. This new design also minimizes heat transfer, which contributes to a more stable imaging environment. Towards this end, the power consumption of the Z-drive motor has also been reduced.

Combined, these mechanical redesigns result in an ultra-stable imaging platform, perfectly suited for single-molecule imaging and super-resolution applications.

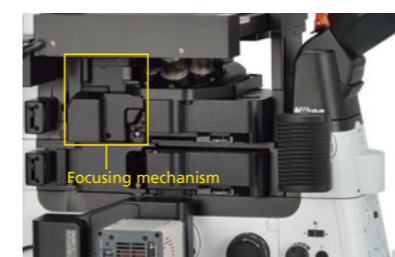

High stability Z-focusing mechanism remains adjacent to the nosepiece even in expanded configurations



Real time focus correction with the PFS: Simply perfect (Ti2-E)

The Perfect Focus System (PFS) automatically corrects focus drift caused by temperature changes and mechanical vibrations, which can be caused by a variety of factors including the addition of reagents to the sample and multi-position imaging.

The PFS maintains focus by detecting and tracking the position of the coverslip surface in real time. Unique optical offset technology allows users to easily maintain focus at a desired position offset from the cover slip surface. The PFS automatically and continuously maintains focus by means of a built-in linear encoder and high speed feedback mechanism, providing highly reliable images even during long-term, complex imaging tasks.

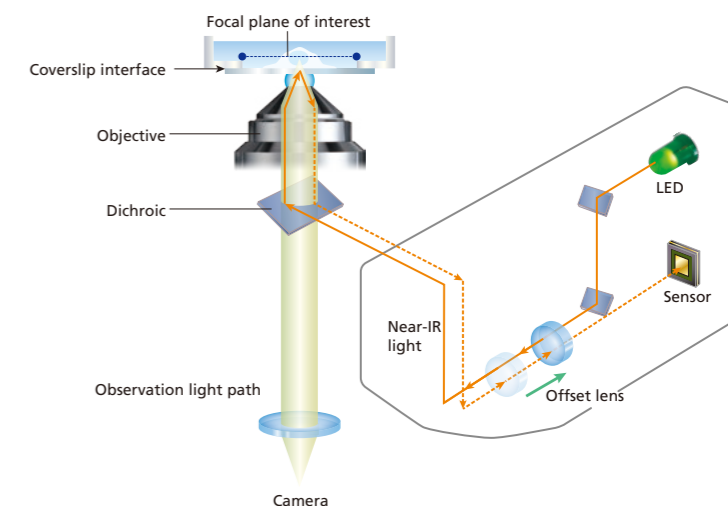

Water Immersion Dispenser (Ti2-E)

The performance of long-term imaging using the PFS together with water immersion objectives can be increased by using the new Water Immersion Dispenser. The Water Immersion Dispenser automatically applies the appropriate amount of pure water to the tip of an objective, preventing the immersion liquid from drying out and overflowing during experiments. It is compatible with all types of water immersion objectives and helps to stably provide high-resolution, high-contrast and aberration-corrected time-lapse images over long periods of time.



Dual micro nozzle geometry automatically keeps the proper amount of water on the tip of water immersion objectives.

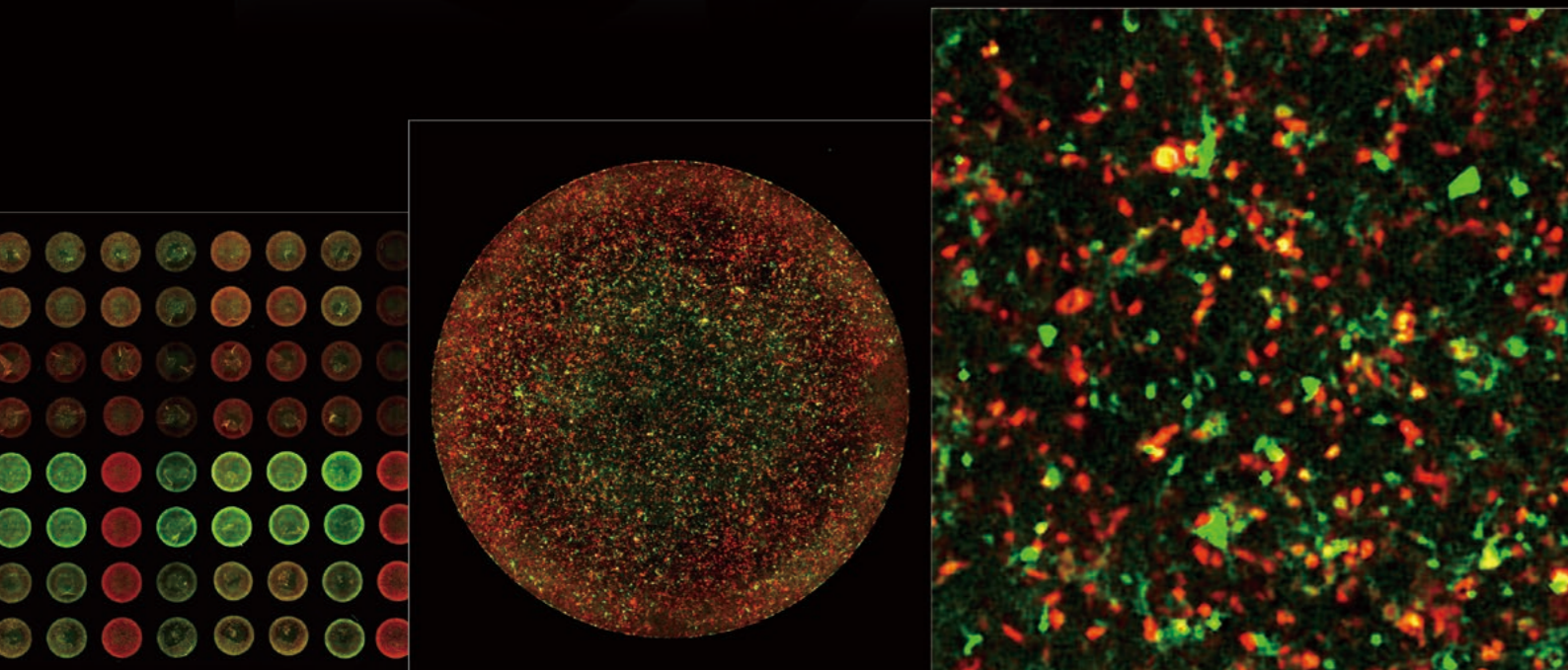

Images on page 8
 Stitched large image of an entire 96-well plate using PFS and a CFI Plan Apochromat Lambda 4X objective; each well contains neuronal cultures expressing red and green fluorescent proteins. Sample courtesy of Jeanette Osterloh and Steve Finkbeiner, Gladstone Institutes, UCSF



It is no longer necessary to memorize complex microscope alignment and operation procedures. The Ti2 integrates data from sensors to guide you through these steps, eliminating user error and enabling researchers to concentrate on their data.

Continuous display of microscope status (Ti2-E/A)

A collection of built-in sensors detects and relays status information for a variety of components in the microscope. All of the status information is recorded in the metadata when you acquire images with a computer, so you can easily recall acquisition conditions and/or check for configuration errors.

In addition, a built-in internal camera allows users to view the back aperture, facilitating confirmation of phase ring alignment and extinction cross in DIC. It also provides a laser-safe method for aligning lasers for applications such as TIRF.

Microscope status can be viewed on a tablet and also determined based on status lights on the front of the microscope, enabling status determination in a dark room.



Status lights



Built-in sensors detect the status of microscope components

Guidance for operational procedures (Ti2-E/A)

The Ti2's Assist Guide function provides interactive step-by-step guidance for microscope operation. The Assist Guide can be viewed on a tablet or PC, and integrates real time data from built-in sensors and an internal camera. The Assist Guide is designed to help users through alignment procedures for both experiment setup and troubleshooting.

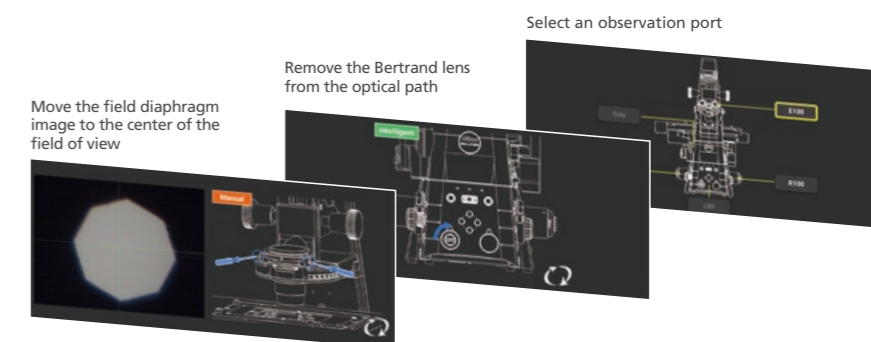

Automatically detect errors (Ti2-E/A)

The Check Mode allows users to easily confirm, on either a tablet or PC that all the correct microscope components are in place for their chosen observation method. This capability eliminates time and effort normally required for troubleshooting when the desired observation method is not achieved. This functionality is particularly advantageous when multiple users are involved, each with the potential to make unexpected changes to the microscope settings. Custom check procedures can also be pre-programmed.

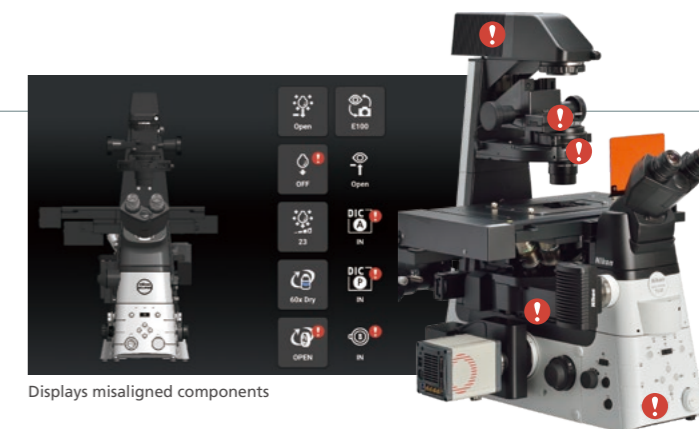

Displays misaligned components

Intuitive operation



The Ti2 has been completely redesigned, from the overall body design to the selection and placement of every button and switch, for the ultimate in user experience. The controls are easy to use even in the dark, where the majority of imaging experiments are conducted. The Ti2 provides an intuitive and effortless user interface so researchers can focus on the data and not on microscope control.

Thoughtfully designed layout for microscope control (Ti2-E/A)

The placement of all of the buttons and switches are based on the type of illumination they control. Buttons that control diascopic observation are positioned on the left side of the microscope and those that control epi-fluorescence observation are on the right side. Buttons that control common operations are on the front panel. This use of zoning provides an easy-to-remember layout, a desirable feature when operating the microscope in a dark room.

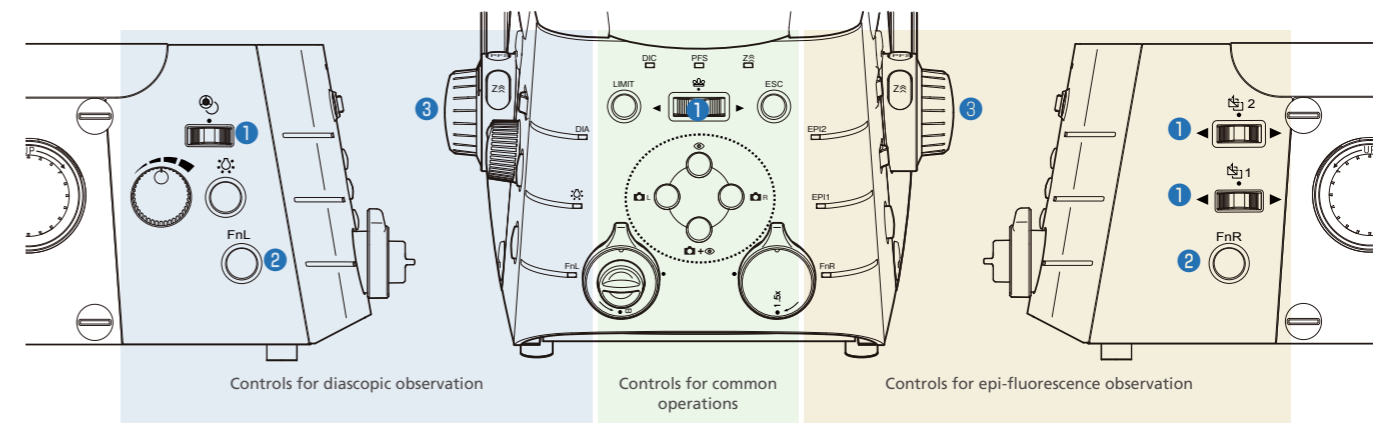

1 Shuttle switch (Ti2-E)

Shuttle switches have been incorporated into the design to control devices such as the epi-fluorescence filter cube turret and objective nosepiece. These types of switches emulate the feel of manually rotating these devices, for intuitive control. Additional functionality can be incorporated into these shuttle switches so that a single switch can operate multiple related devices. For example, the shuttle switch for the epi-fluorescence filter cube turret not only rotates the turret but also opens and closes the fluorescence shutter when the user presses the switch. It is also possible to program these switches to operate a barrier filter wheel and the external phase contrast unit.

2 Programmable Function button (Ti2-E/A)

Conveniently located Function buttons allow customization of the user interface. Users can select from more than 100 functions, including control of motorized devices such as shutters and even signal output to external devices via the I/O port for triggered acquisition. Mode functions, which enable instant changing of observation methods by storing the settings of each motorized device, can also be assigned to these buttons.

3 Focusing knob (Ti2-E)

A focus acceleration button and a PFS engagement button are provided adjacent to the focusing knobs. The two buttons are easily identified by touch because of their different shapes. Focusing speed is automatically adjusted for the objective in use, enabling stress-free operation by maintaining an ideal focusing speed.

Intuitive control with joystick and tablet (Ti2-E)

The Ti2 joystick not only controls stage movement, but the majority of motorized functions on the microscope, including PFS activity. It can display XYZ coordinates and the status of microscope components, providing an effective means for the user to remotely control the microscope. Motorized functions of the Ti2 can also be controlled from a tablet, connected by wireless LAN to the microscope, providing a versatile graphical interface for microscope control.



System expandability



Stage up kit

Allows expansion of the infinity space for incorporation of additional devices such as a second epi-fluorescence filter cube turret, barrier filter wheel, back port unit, and LAPP modules.



Epi-fluorescence filter cube turret

Compatible with large FOV. A manual intelligent model and high-speed motorized models with motorized shutter are available.



Motorized barrier filter wheel

Provides high-speed filter switching (50msec. switch time between adjacent positions) and is compatible with large FOV. It can also be mounted in the infinity space, under the epi-fluorescence filter cube turret, when the stage is raised.

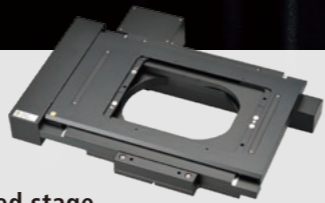

Motorized stage

Control methods are optimized for fast stage operation. A stage with a built-in encoder and a piezo stage for Z-stacking are available. Magnetic specimen holders ensure safe operation.



Auto Correction Collar

Changes in sample/coverglass thickness, refractive index distribution and temperature can lead to image deterioration. This unique auto correction collar utilizes a harmonic drive and automatic correction algorithm to achieve precise collar adjustment.



Fluorescence LED light source

An eco-friendly light source optimized for fluorescence observation. It is a light source that can be directly mounted on the epi-fluorescence module.



Motorized TIRF Module

The incident angle of the laser and corresponding penetration depth of the evanescent field can be controlled via NIS-Elements software. When multiple TIRF modules are mounted (see image), the penetration depth can be independently set for each wavelength.



Condenser turret

Three types are available: manual, intelligent, and a motorized type that automatically switches between seven positions to accommodate different imaging modes.

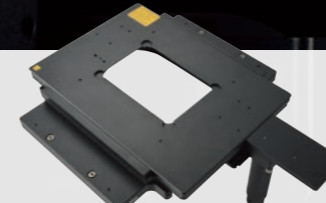

Manual stage

A long travel stroke allows observation of the entire area of a well plate. The travel area can be restricted to ensure safe operation. Various specimen holders are available.



Stage top incubator

The STX series precisely maintains temperature at 37.0°C and humidity at more than 95%, and controls CO₂ to enable culturing of cells for more than 1 week.

Manufactured by Tokai Hit Co., Ltd.



Oil hydraulic micromanipulator

The MTK-1-N4 achieves simple, easy pipette alignment and smooth pipette movement by means of a four-axis hydraulic joystick.

Manufactured by Narishige Lifemed Co., Ltd.



LAPP system

Various illumination modules, such as TIRF and photostimulation modules, can be flexibly combined to customize your imaging system. Up to five modules can be mounted simultaneously.



Field stop sliders

Two different rectangular-shaped apertures and one round aperture model are available. The rectangular models prevent excitation outside of the imaging area and unintentional photobleaching of samples. They can be removed for ultra-wide FOV imaging.



Confocal microscopes

The AX high-resolution/AX R ultrafast high-resolution confocal system. Multiphoton versions A1 MP+/A1R MP+ are also available.

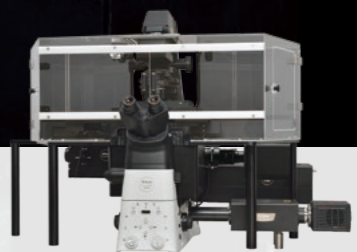

Super Resolution Microscopes

N-SIM S, which achieves live-cell imaging with double the resolution of conventional optical microscopes, and N-STORM, which achieves ten times the resolution of conventional optical microscopes for molecular-level observation, are available.

A unified acquisition and analysis software platform

Nikon's unified software platform, NIS-Elements, provides acquisition control for basic to advanced imaging systems as well as powerful analysis tools and stunning display capabilities. NIS-Elements can be streamlined for simple, turnkey use and expanded for fully customized, complex experiments such as conditional workflows. NIS-Elements also offers easy-to-use, graphical programming tools such as JOBS and Illumination Sequence for customizing tasks. In addition to Nikon hardware, NIS-Elements controls devices from a vast array of manufacturers to enable the highest level of customization.



Device Control

Multidimensional Imaging

Optical Configuration (OC) settings memorize custom observation modes and are combined in the ND Acquisition GUI to easily create experiments combining multi-channel, multi-stage position, z-stacking, and timelapse imaging, as well as image stitching. Other functions such as photostimulation and photobleaching can also be flexibly combined.

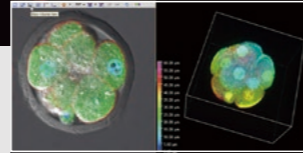

High-speed hardware control

The Ti2's unique hardware triggering capabilities remove software callbacks during acquisition routines to maximize imaging speed. The Illumination Sequence module provides a simple, graphical interface for quickly designing and verifying complex, triggered acquisition experiments.

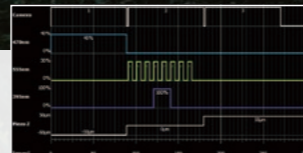

Graphical programming for custom tasks

For complex or unique image acquisition needs, the JOBS tool provides an easy-to-use graphical interface for creating custom workflows using drag-and-drop features.

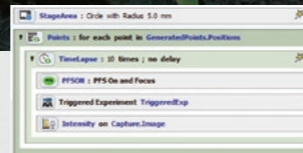

Control of Third Party Products

NIS-Elements can natively control a vast number of devices from a variety of manufacturers including high-sensitivity cameras, piezo-devices, light sources, wheels, and National Instruments DAQ devices. This flexibility in hardware control enables custom configurations tailored to individual research needs.

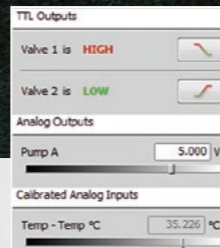

Display & Processing

Multi-dimensional Display

Multi-dimensional images that combine multichannel, time-lapse, Z stack, and multi-XY position imaging, as well as image stitching are intuitively displayed in a single window. Powerful volume rendering tools provide unrivalled image quality and interactivity while the Movie-Maker feature enables users to easily create stunning movies.

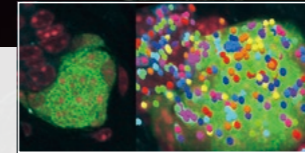

Advanced Image Processing

Advanced filters for sharpening, smoothing, and denoising as well as real-time shading correction and image averaging for noise reduction are available. NIS-Elements also offers advanced image arithmetic tools as well as a variety of image projection options such as extended depth of focus (EDF).



Deconvolution

Automatic and manual modes, robust algorithms for noise measurement and removal, and enhanced spherical aberration correction are provided to help actualize theoretical resolutions for even confocal images. Both 3D and 2D deconvolution options are available.

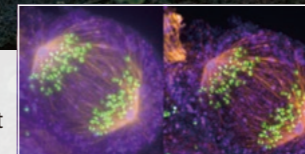
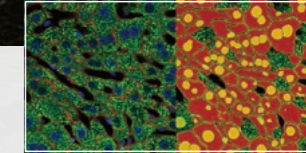

Image Analysis

Automatic measurement

A combination of powerful segmentation tools, morphology functions, classifiers, and an extensive list of measurement tools for 2D, 3D and timelapse datasets enable users to extract quantitative information from their data with ease. Interactive/manual measurement options are also available.



Real-time measurement

Time measurements can be carried out in real time and visualized during acquisition. Real-time analysis results can be especially useful for optimizing experiments that rely on drug treatments or ratiometric imaging like FRET or FRAP.

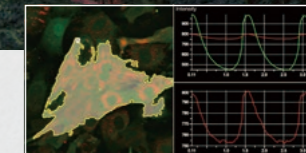

2D and 3D Object Tracking

NIS-Elements provides powerful tools for identifying and tracking 2D and 3D objects. Measurements include velocity, acceleration, distance, and direction. A variety of innovative display options are available for communicating and presenting tracking analysis results.

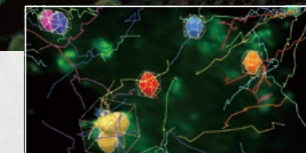

Custom Analysis Routines

The General Analysis (GA) module provides an easy method for creating custom analysis routines that combine image processing and measurement. Routines created in GA can be saved and recalled and even combined with JOBS to create conditional acquisition workflows that rely on real-time analysis results from the integrated GA routine.

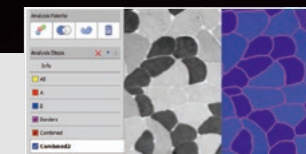

System Diagram

Motorized accessories (with status detection function)

Accessories with status detection function

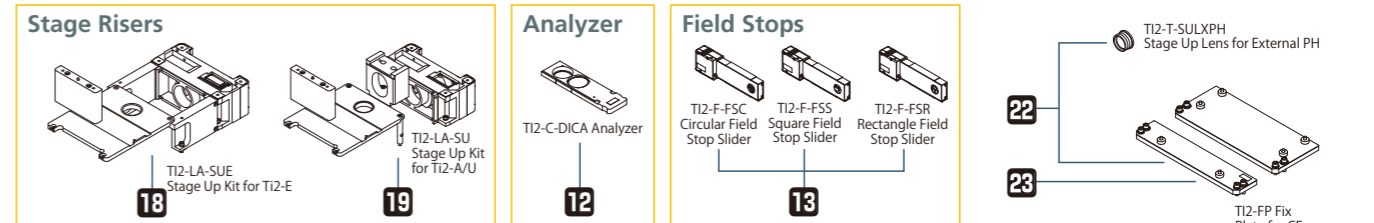
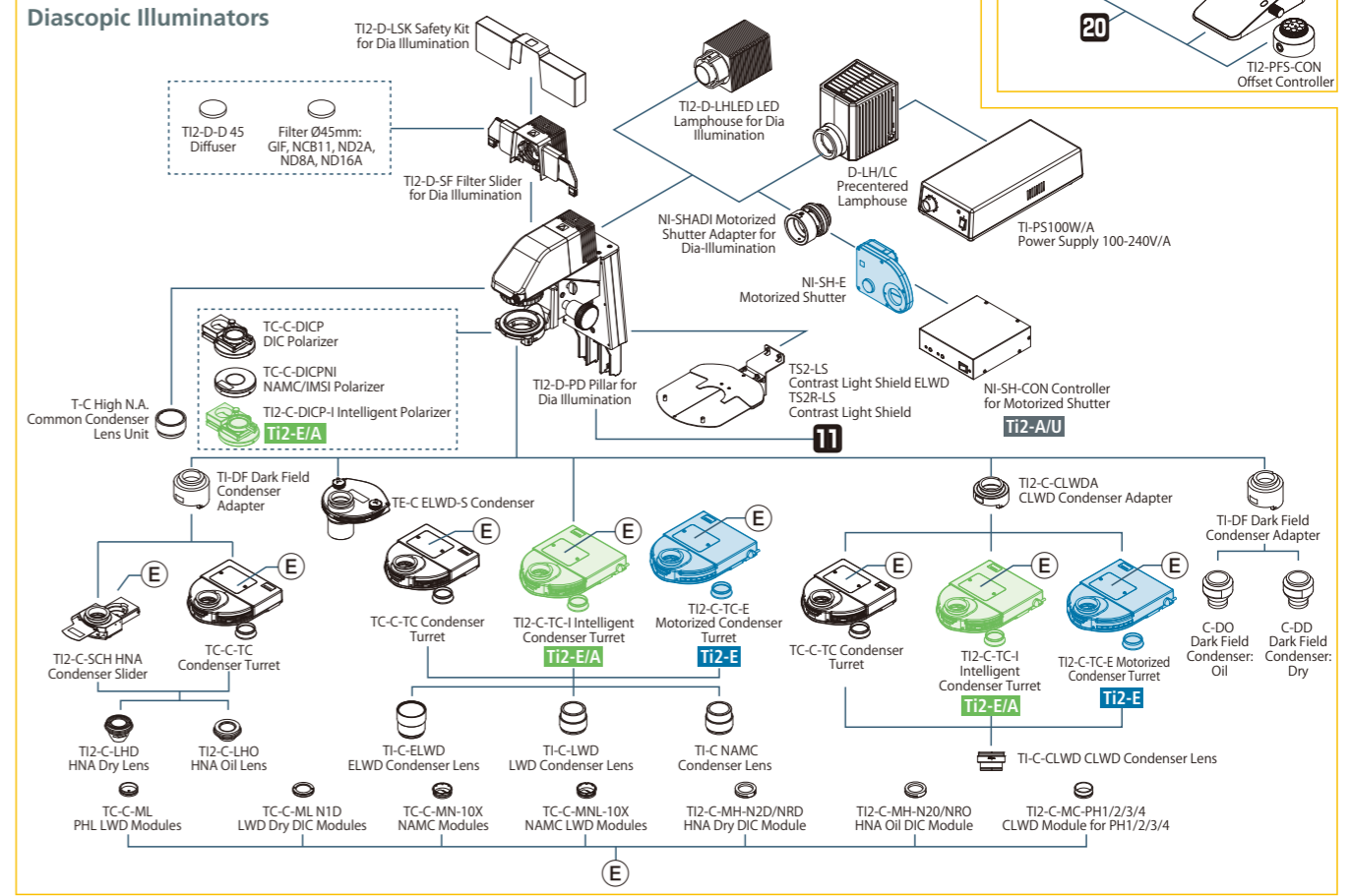
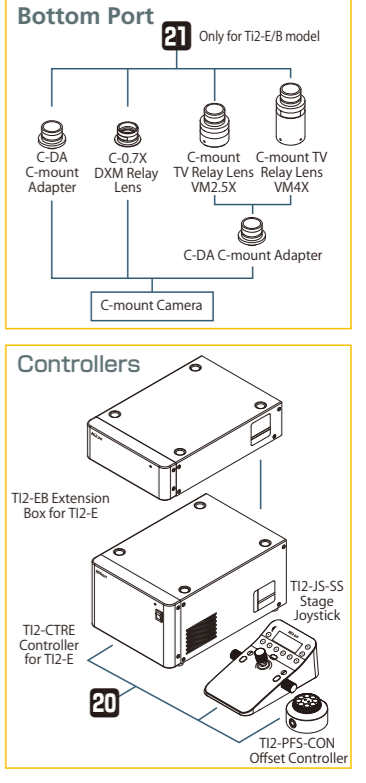
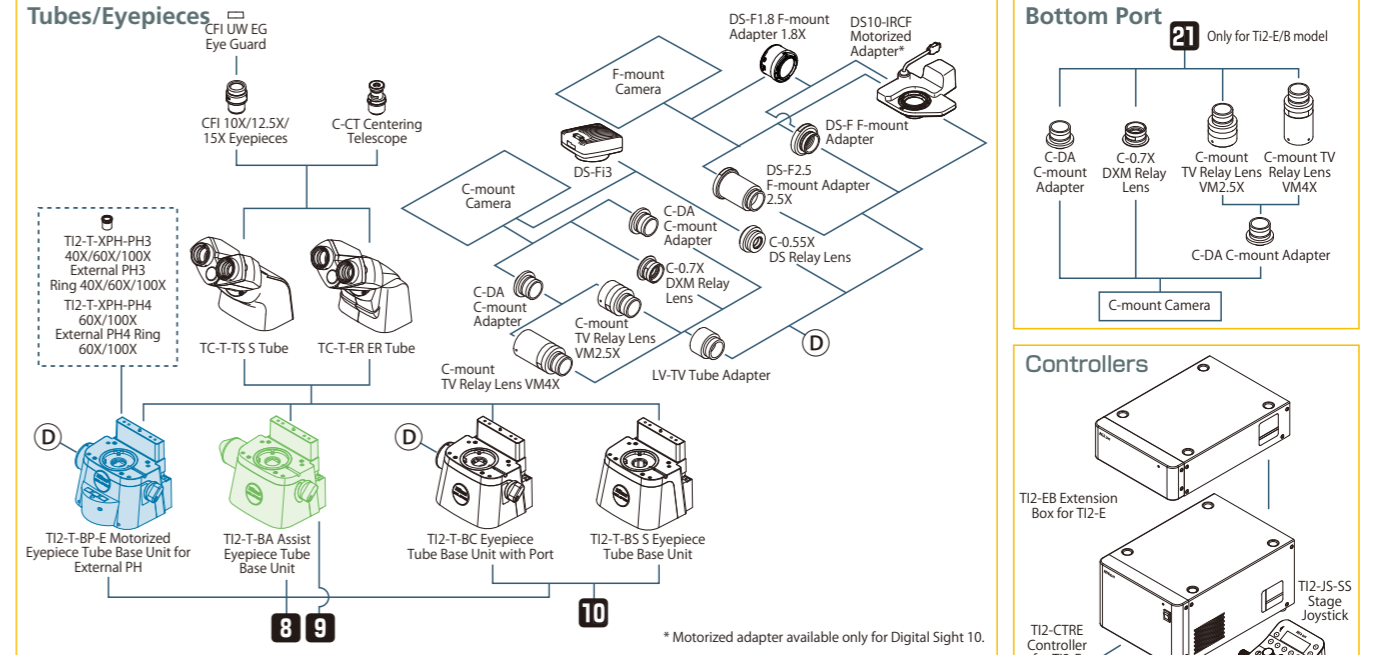
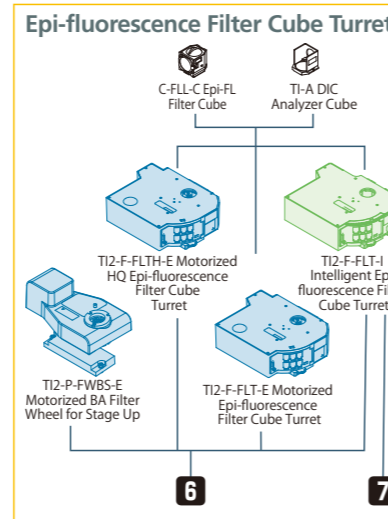
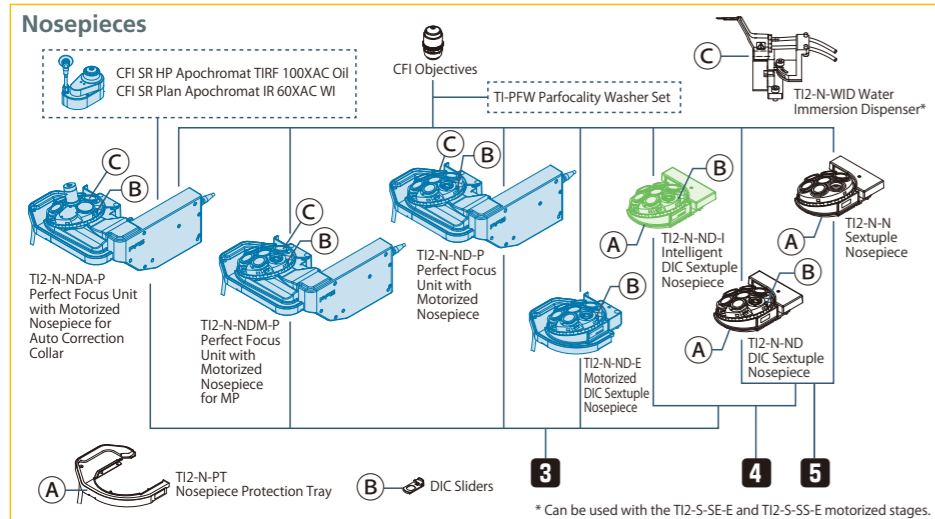
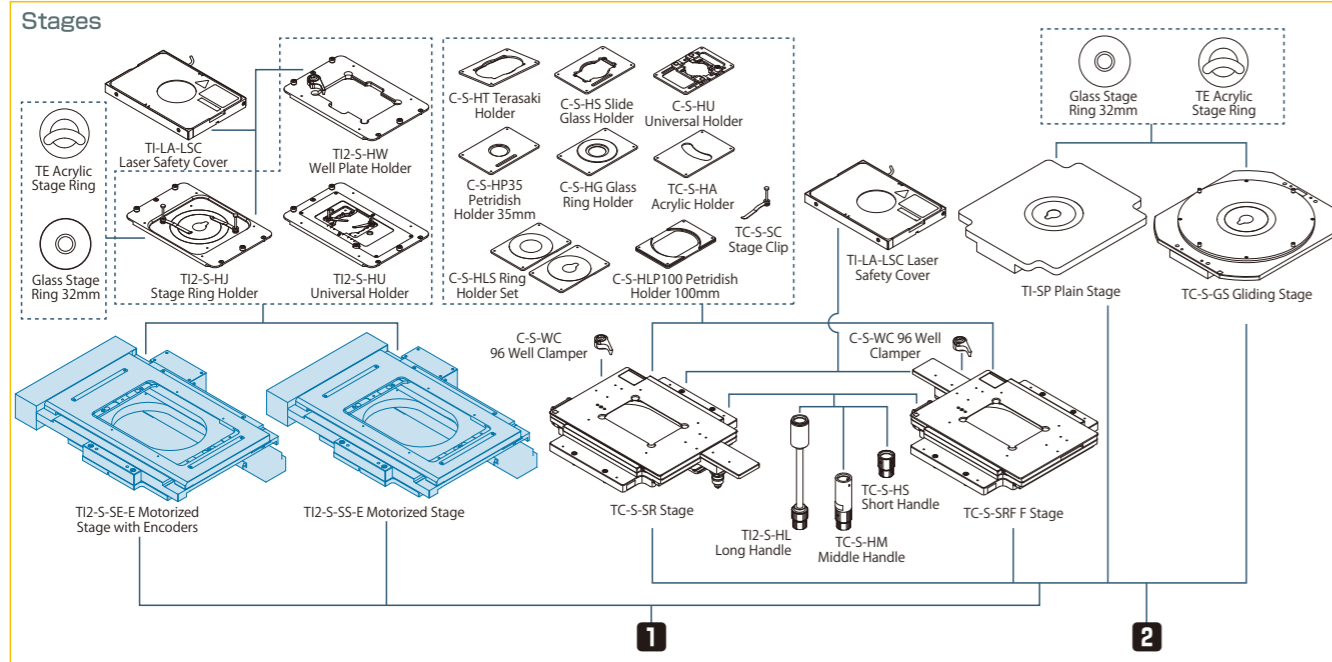
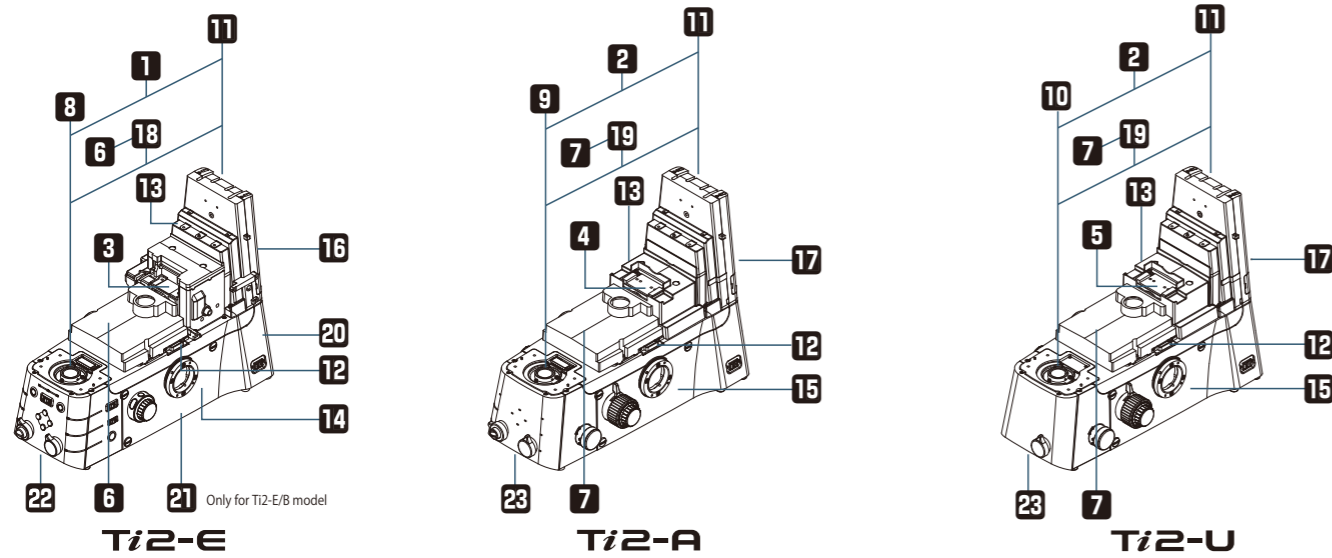

System Diagram

Motorized accessories (with status detection function)

Accessories with status detection function

Side Port

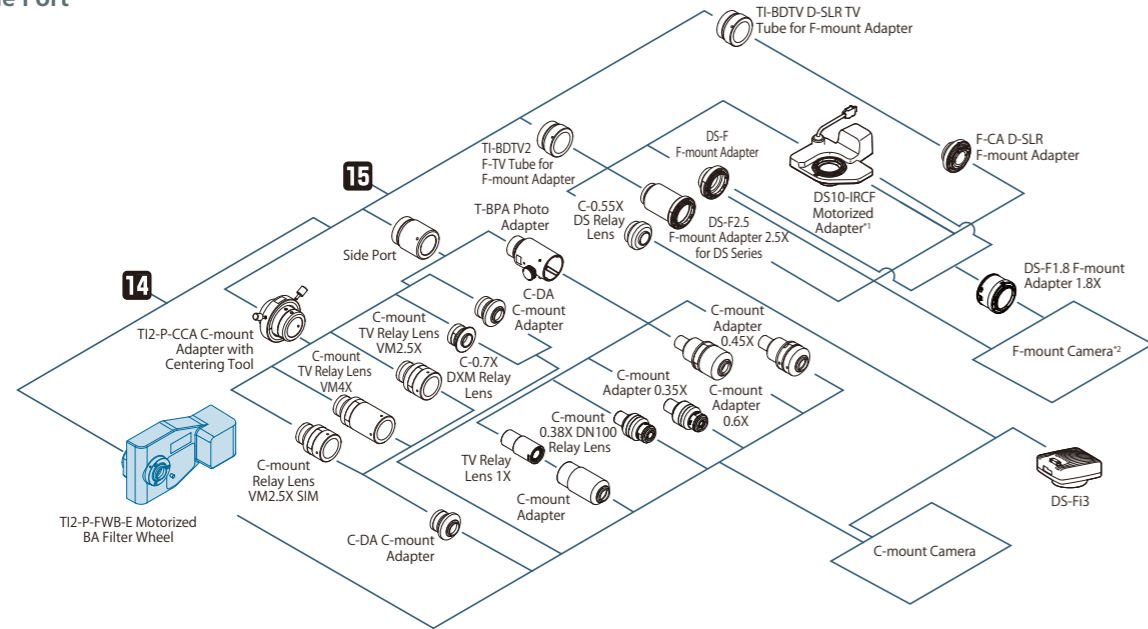

*1 Motorized adapter available only for Digital Sight 10.
*2 There are restrictions on some camera combinations. For more information, please consult Nikon.

Fluorescence Illuminators

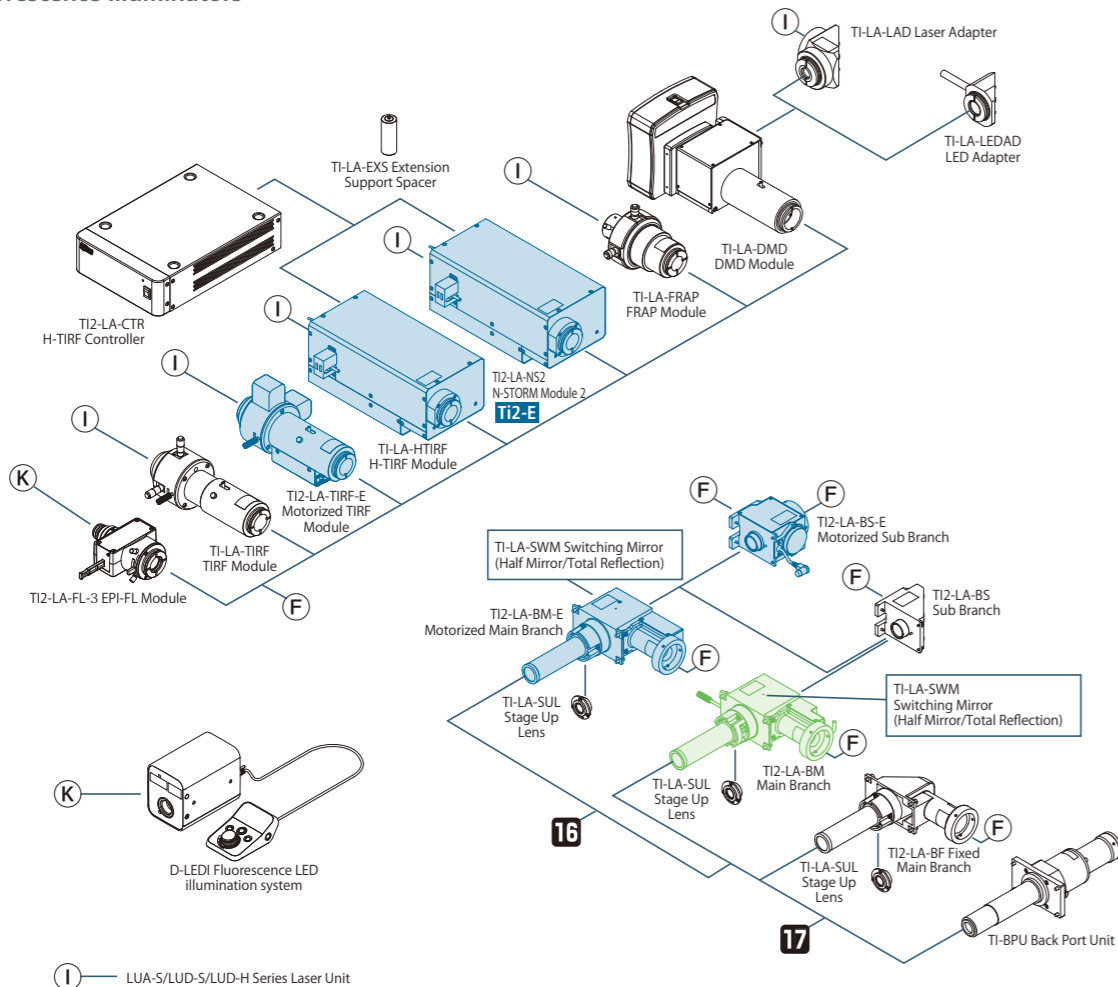

① LUA-S/LUD-S/LUD-H Series Laser Unit

Objectives

Type	Model	Immersion	NA	W.D. (mm)	Cover glass thickness	Correction ring	Spring loaded	DIC	Phase contrast	Fluorescence			
										UV	Visible light	NIR	PFS
Plan Fluor	CFI Plan Fluor	4X		0.13	17.20	—				○	○		
		10X		0.30	16.00	0.17			○		○	○	✓
		20X		0.50	2.10	0.17			○		○	○	
		20XC MI	Oil Glycerin Water	0.75	0.51-0.35 0.51-0.34 0.49-0.33	0.17	✓	✓	○		○	○	
		40X		0.75	0.66	0.17		✓	○		○	○	✓
		40X Oil	Oil	1.30	0.24	0.17		✓/stopper	○	EXT PH3-40x	○	○	✓
		60XC		0.85	0.40-0.31	0.11-0.23	✓	✓	○		○	○	
		60XS Oil	Oil	0.50-1.25	0.22	0.17		✓	○	EXT PH3-60x	○	○	
		100X Oil	Oil	1.30	0.16	0.17		✓/stopper	○		○	○	✓
		100XS Oil	Oil	0.50-1.30	0.16	0.17		✓	○		○	○	
		DL 4XF		0.13	16.50	1.20				PHL	○	○	
		DLL 10X		0.30	16.00	0.17				PH1	○	○	✓
		DL 10XF		0.30	15.20	1.20				PH1	○	○	✓
		DLL 20X		0.50	2.10	0.17				PH1	○	○	✓
		DLL 40X		0.75	0.66	0.17				PH2	○	○	✓
DLL 100X Oil	Oil	1.30	0.16	0.17			✓/stopper	PH3	○	○	✓		
ADH 100X Oil	Oil	1.30	0.16	0.17			✓/stopper	PH3	○	○	✓		
S Plan Fluor	CFI S Plan Fluor	LWD 20XC		0.70	2.30-1.30	0-1.80	✓		○		○	○	✓
		ELWD 20XC		0.45	8.20-6.90	0-2.00	✓		○		○	○	✓
		ELWD 40XC		0.60	3.60-2.80	0-2.00	✓		○		○	○	✓
		ELWD 60XC		0.70	2.60-1.80	0.10-1.30	✓		○		○	○	
		LWD ADM 20XC		0.70	2.30-1.30	0-1.80	✓			PH2	○	○	✓
		ELWD ADM 20XC		0.45	8.20-6.90	0-2.00	✓			PH1	○	○	✓
		ELWD ADM 40XC		0.60	3.60-2.80	0-2.00	✓			PH2	○	○	✓
		ELWD ADL 60XC		0.70	2.60-1.80	0.10-1.30	✓			PH2	○	○	
		ELWD NAMC 20XC		0.45	8.20-6.90	0-2.00	✓				○	○	
ELWD NAMC 40XC		0.60	3.60-2.80	0-2.00	✓				○	○			
Super Fluor	CFI Super Fluor	4X		0.20	15.50	—				○	○	○	✓
		10X		0.50	1.10	0.17		✓	○		○	○	✓
		20X		0.75	1.00	0.17		✓	○		○	○	✓
		40XC		0.90	0.34-0.26	0.11-0.23	✓	✓	○		○	○	
		40X Oil	Oil	1.30	0.19	0.17		✓/stopper	○		○	○	✓
		100XS Oil	Oil	0.50-1.30	0.20	0.17		✓			○	○	
											○	○	
Plan Apochromat	CFI Plan Apochromat	Lambda D 2X		0.10	8.50	0-0.17					○	○	○
		Lambda D 4X		0.20	20.00	0-0.17					○	○	○
		Lambda D 10X		0.45	4.00	0.17			○		○	○	✓
		Lambda D 20X		0.80	0.80	0.17		✓	○		○	○	✓
		Lambda D 40XC		0.95	0.21	0.11-0.23	✓	✓	○		○	○	✓
		Lambda D 60X Oil	Oil	1.42	0.15	0.17		✓	○	EXT PH3-60x	○	○	○
		Lambda D 100X Oil	Oil	1.45	0.13	0.17		✓	○	EXT PH3-100x	○	○	○
		Lambda S 10X		0.45	4.00	0.17			○		○	○	✓
		Lambda S 25XC Sil	Silicone Oil	1.05	0.55	0.11-0.23	✓		○		○	○	✓
		Lambda S 40XC Sil	Silicone Oil	1.25	0.30	0.13-0.21 (23°C) 0.15-0.23 (37°C)	✓		○		○	○	✓
		VC 60XC WI**	Water	1.20	0.31-0.28	0.15-0.18	✓	✓	○	EXT PH3-60x	○	○	✓
		IR 60XC WI**	Water	1.27	0.18-0.16	0.15-0.19	✓	✓	○	EXT PH3-60x	○	○	✓
		10XC Glyc	Oil Glycerin Water	0.50	2.00***	0-0.17	✓				○	○	
Plan Apochromat	CFI HP Plan Apochromat	VC 100X Oil	Oil	1.40	0.13	0.17		✓	○	EXT PH3-100x	○	○	✓
		IR 60XC WI**	Water	1.27	0.18-0.16	0.15-0.19	✓		○	EXT PH3-60x	○	○	✓
		IR 60XC WI***	Water	1.27	0.18-0.16	0.15-0.19	✓		○	EXT PH3-60x	○	○	✓
Plan Apochromat	CFI SR HP Plan Apochromat	Lambda S 100XC Sil	Silicone Oil	1.35	0.31-0.29 (23°C) 0.30-0.28 (37°C)	0.15-0.19	✓		○		○	○	✓
		Lambda S 20XC WI**	Water	0.95	0.99-0.90	0.11-0.23	✓		○		○	○	✓
Apochromat	CFI Apochromat	LWD Lambda S 40XC WI**	Water	1.15	0.61-0.59	0.15-0.19	✓		○	EXT PH3-40x	○	○	✓
		Lambda S 40XC WI**	Water	1.25	0.20-0.16	0.15-0.19	✓	✓	○	EXT PH3-40x	○	○	✓
		TIRF 60XC Oil	Oil	1.49	0.16-0.10 (23°C) 0.13-0.07 (37°C)	0.13-0.19 (23°C) 0.15-0.21 (37°C)	✓		○	EXT PH4-60x	○	○	✓
		TIRF 100XC Oil	Oil	1.49	0.16-0.10 (23°C) 0.15-0.09 (37°C)	0.13-0.19 (23°C) 0.14-0.20 (37°C)	✓		○	EXT PH4-100x	○	○	✓
		TIRF 100XC Oil*	Oil	1.49	0.16-0.10 (23°C) 0.15-0.09 (37°C)	0.13-0.19 (23°C) 0.14-0.20 (37°C)	✓		○	EXT PH4-100x	○	○	✓

○ : recommended for best results
○ : suitable
● : possible with visible light that has a longer wavelength than excitation light used for DAPI

EXT : external phase contrast modules
340 : high transmittance with an ultraviolet wavelength range of up to 340 nm
CF : confocal imaging is possible at 488 nm and above

* Compatible with Auto Correction Collar
** Compatible with Water Immersion Dispenser
*** 5.50 for upright microscopes

Specifications

		ECLIPSE Ti2-E, Ti2-E/B*1	ECLIPSE Ti2-A	ECLIPSE Ti2-U
Main body	Optical system	Infinity-corrected CF160		
	Field number*2	22 with C-mount, 25 with F-mount		
	Intermediate Magnification switching	Manual switching of 1.0x/1.5x (exchangeable from 1.5x to 2.0x)		
		Status detection	—	
	Bertrand lens	Manual in/out, and manual focus, Status detection		
	Output port	4 Motorized positions Eyepiece 100%, left 100%, right 100%, eyepiece 20%/left 80% (Ti2-E/B: bottom 100%)	4 Manual positions Eyepiece 100%, left 100%, right 100%, option (to eyepiece 20%/left 80% or eyepiece 20%/right 80%)	
		Can add ports by use of back port unit and/or choice of tube base unit*3		
Focusing unit	Motorized drive, Coarse/fine focus changeover, 10mm stroke, Minimum increments: 0.01µm, 0.02µm (with encoder control)	Manual drive, Coarse/fine focusing knob, 10mm stroke		
Stage up	Available*4			
Tube body	Binocular tube	Binocular S tube TC-T-TS (field number 22), Ergonomic ER tube TC-T-ER (field number 22)		
	Motorized eyepiece tube base unit for external PH (Ti2-T-BP-E)	Camera port (field number 16), Motorized PH turret with 4 motorized positions	—	
	Assist eyepiece tube base unit (Ti2-T-BA)	Assist camera (field number 22), Status detection	—	
	Eyepiece tube base unit with port (Ti2-T-BC)	Camera port (field number 16)	—	Camera port (field number 16)
Transmitted illumination	Pillar for transmitted illumination (Ti2-D-PD)	Condenser vertical stroke: 66mm, Backward tilting up to 25 degrees, With field diagram and refocusing mechanism 2 filter slot positions (4 filter position option is also available with Filter Slider for transmitted illumination (Ti2-D-SF))		
	LED Lamphouse for dia illumination (Ti2-D-LHLED)	High power LED		
	Precentered Lamphouse (D-LH/LC)	100W halogen bulb (pre-centered)		
Condenser	Motorized condenser turret (Ti2-C-TC-E)	7 motorized positions (Ø37mm x4, Ø39mm x3), LWD/ELWD/CLWD/NAMC condenser lenses are supported	—	
	Intelligent condenser turret (Ti2-C-TC-I)	7 manual positions (Ø37mm x4, Ø39mm x3), Status detection, LWD/ELWD/CLWD/NAMC condenser lenses are supported	—	
	Condenser turret (TC-C-TC)	7 manual positions (Ø37mm x4, Ø39mm x3), LWD/ELWD/CLWD/NAMC condenser lenses are supported		
	ELWD-S condenser turret (TE-C)	4 manual positions, With ELWD condenser lens (O.D.=65mm, NA=0.3)		
	HNA condenser slider (Ti2-C-SCH)	2 manual positions (Ø37mm x1, Ø39mm x1), HNA dry lens/HNA oil lens are supported		
Condenser lens	LWD (O.D.=30mm, NA=0.52), ELWD (O.D.=75mm, NA=0.29), CLWD (O.D.=13mm, NA=0.72), HNA dry (O.D.=5mm, NA=0.85), HNA oil (O.D.=2mm, NA=1.4), NAMC (O.D.=44mm, NA=0.4)			
Stage	Motorized stage (Ti2-S-SE-E, Ti2-S-SS-E)	Stroke X: ±57mm, Stroke Y: ±36.5mm, Max drive speed: approx. 25mm/sec, Magnetic sample holder	—	
	Stage (TC-S-SR, TC-S-SRF)	Stroke X: ±57mm, Stroke Y: ±36.5mm, Adjustable stroke range (3 levels) with adjusting pin, Long/middle/short handle options available		
	Gliding stage (TC-S-GS)	Stroke Ø20mm		
Nosepiece	Perfect Focus Unit with motorized nosepiece for Auto Correction Collar (Ti2-N-NDA-P)	5 motorized positions, Simple waterproof structure	—	
	Motorized DIC sextuple nosepiece (Ti2-N-ND-E) Perfect Focus Unit with motorized nosepiece (Ti2-N-ND-P) Perfect Focus Unit with motorized nosepiece for MP (Ti2-N-NDM-P)	6 motorized positions, Simple waterproof structure	—	
	Intelligent DIC sextuple nosepiece (Ti2-N-ND-I)	6 manual positions, Status detection, Simple waterproof structure	—	
	Sextuple nosepiece (Ti2-N-N), DIC sextuple nosepiece (Ti2-N-ND)	6 manual positions, Simple waterproof structure		
Epi-fluorescence filter cube turret	Motorized epi-fluorescence filter cube turret (Ti2-F-FLTH-E, Ti2-F-FLT-E)	6 motorized positions, Motorized shutter	—	
	Intelligent epi-fluorescence filter cube turret (Ti2-F-FLT-I)	6 manual positions, Manual shutter, Status detection*5	—	
Filter wheel/shutter	Motorized BA filter wheel (Ti2-P-FWB-E)	7 motorized positions, High speed mode: 50ms, Low vibration mode: 100ms (movement time between adjacent positions)	—	
	Motorized shutter (NI-SH-E)*6	12ms to open/close		
Epi-fluorescence attachment	EPI-FL module (Ti2-LA-FL-3)	Supports D-LED1 Fluorescence LED; includes 2-position filter slider and aperture diaphragm In combination with the C-FIBA Adapter for fiber light, fiber illumination can be used		
	Field stop slider	Circular (Ti2-F-FSC), rectangular (Ti2-F-FSR), square (Ti2-F-FSS) aperture options		
Control unit	Controller, display device	Stage joystick (Ti2-JS-SS), Tablet	Tablet	—
	Controller for Ti2-E (Ti2-CTRE)	USB/LAN interface, I/O function		
Operating environmental	Temperature: 0°C+40°C, Humidity: 60% RH max. (at +40°C, no condensation), Indoor use only			

Motorized accessories have a status detection function

*1 Motorized model with a bottom port

*2 Limitations apply based on objective and filter cube choice, stage-up configuration, and illumination module, etc.

*3 Tube base units with a port cannot be used with Ti2-A

*4 Stage up kit is required. Please contact Nikon.

*5 Status detection cannot be used when attached to the Ti2-U

*6 NI-SH-CON Controller for Motorized Shutter is required for use with the Ti2-A/Ti2-U

Dimensional Diagram

Ti2-E

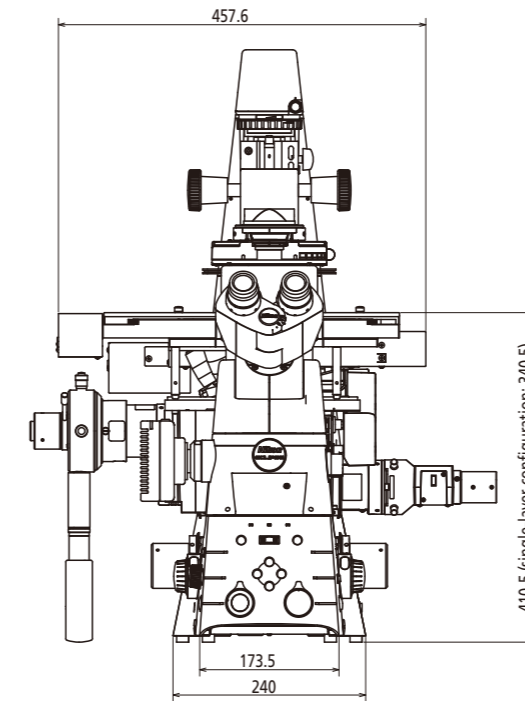

Double layer configuration with an Epi-FL module and a FRAP module

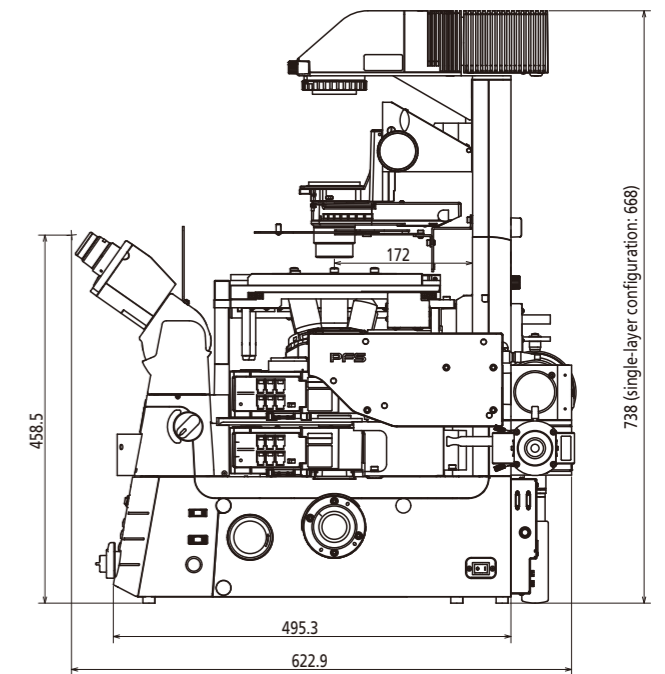

Unit: mm

Ti2-A/U

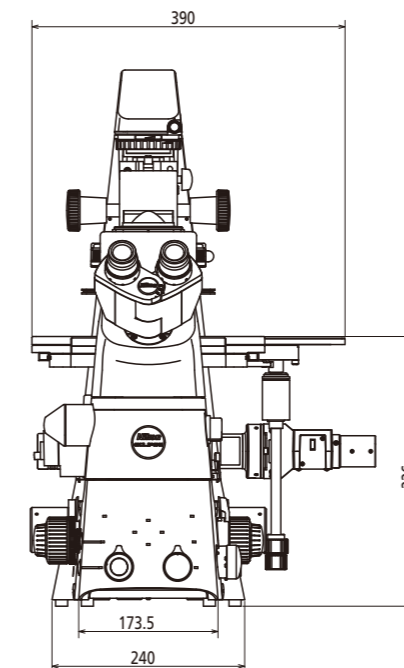

Single layer configuration with an Epi-FL module

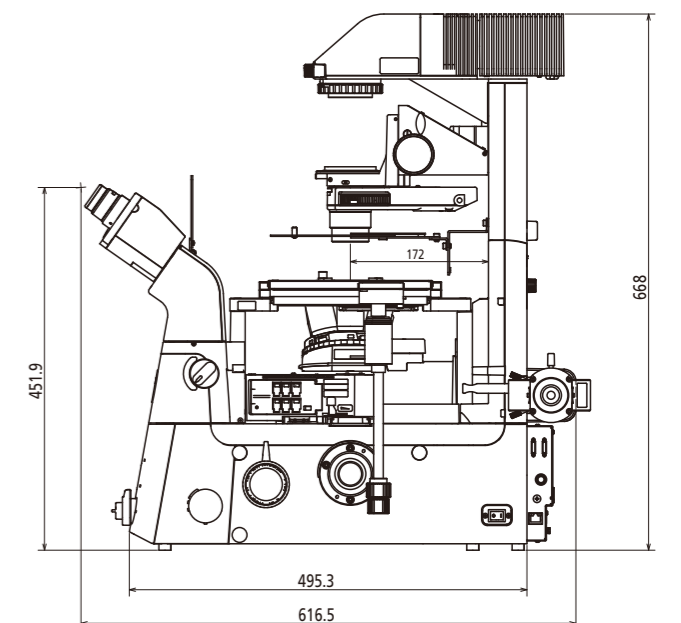

Unit: mm

Illustration is of Ti2-A